

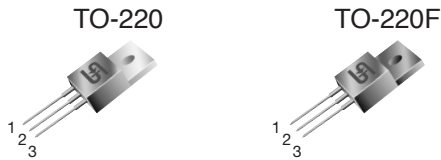

TS7900

3-Terminal Negative Output Voltage Regulators



Pin: 1. Ground 2. Input 3. Output
(Heatsink surface connected to Pin 2.)

Voltage Range
-5 to -24 Volts
Current
1 Ampere

Features

- ✧ Output Current up to 1 Ampere
- ✧ No External Components Required
- ✧ Internal Thermal Overload Protection
- ✧ Internal Short-Circuit Current Limiting
- ✧ Output Transistor Safe-Area Compensation
- ✧ Available in 4% Voltage Tolerance

Ordering Informations

Device	Operating Temperature (Ambient)	Package
TS79xxCZ	-20°C ~ +85°C	TO-220
TS79xxCI		TO-220F

Maximum Ratings (Ta = 25°C)

Rating	Symbol	TS7900 Series	Unit
Input Voltage	V _{in} *1	-35	V
Input Voltage	V _{in} *2	-40	V
Power Dissipation TO-220 TO-220F	P _D	15 10	W
Operating Ambient Temperature	T _{opr}	-20 to +85	°C
Operating Junction Temperature	T _j	0 to +125	°C
Storage Temperature	T _{stg}	-25 to +125	°C

Note: *1: TS7905 to TS7918
*2: TS7924

Follow the derating curve. When T_j exceeds 150°C, the internal circuit cuts off the output.

Standard Application

A common ground is required between the input and the output voltages. The input voltage must remain typically 2.0 V more negative even during the high point on the input ripple voltage.

XX = these two digits of the type number indicate voltage.
C_{in} is required if regulator is located an appreciable distance from power supply filter. C_o improves stability and transient response.

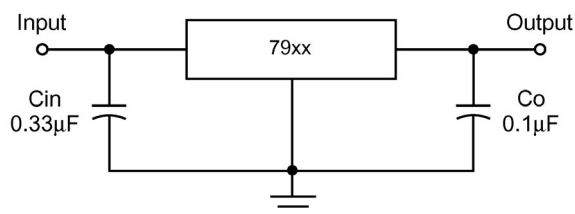

Internal Block Diagram

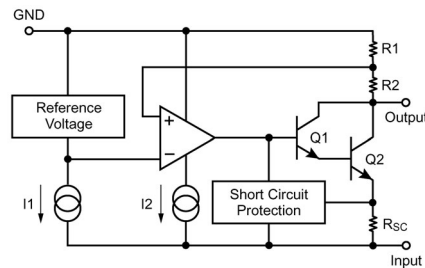

Rev. 1 03/2003



TS7905 Electrical Characteristics								
(Vin = -10V, Iout = 500mA, Cin = 2μF, Cout = 1μF; Tj = 0°C to 125°C, unless otherwise specified.)								
Characteristic	Symbol	Test Circuit	Condition	Min	Typ	Max	Unit	
Output Voltage	Vo	1	Tj=25°C	-4.80	-5.0	-5.20	V	
Output Voltage Tolerance	Vo	1	Vi=-7 to -20V, Io=5mA to 1A, PD<15W	-4.75	-5.0	-5.25	V	
Line Regulation	REGline	1	Tj=25°C	Vi=-7 to -25V	--	3	100	mV
				Vi=-8 to -12V	--	1	50	mV
Load Regulation	REGload	1	Tj=25°C	Io=5mA to 1.5A	--	10	100	mV
				Io=250mA to 750mA	--	3	50	mV
Quiescent Current	Iq	3	Tj=25°C	--	2	4	mA	
Quiescent Current Change	Δ Iq	3	Vi=-7 to -25V	--	--	1.3	mA	
			Io=5mA to 1.5A	--	--	0.5	mA	
Output Noise Voltage	Vn	1	f=10Hz to 100KHz, Ta=25°C	--	40	--	μV	
Ripple Rejection Ratio	RR	2	Vi=-8 to -18V, Io=100mA, f=120Hz	62	74	--	dB	
Min. I/O Voltage Difference	Vdif		Io=1A, Tj=25°C	--	1.1	--	V	
Peak Output Current	Io-peak	1	Tj=25°C	--	2.1	--	A	
Output Voltage Temperature Coefficient	Δ Vo/Ta	1	Io=5mA, Tj=0 to 125°C	--	-0.4	--	mV/°C	

TS7906 Electrical Characteristics								
(Vin = -11V, Iout = 500mA, Cin = 2μF, Cout = 1μF; Tj = 0°C to 125°C, unless otherwise specified.)								
Characteristic	Symbol	Test Circuit	Condition	Min	Typ	Max	Unit	
Output Voltage	Vo	1	Tj=25°C	-5.75	-6.0	-6.25	V	
Output Voltage Tolerance	Vo	1	Vi=-8 to -21V, Io=5mA to 1A, PD<15W	-5.70	-6.0	-6.30	V	
Line Regulation	REGline	1	Tj=25°C	Vi=-8 to -25V	--	4	120	mV
				Vi=-9 to -13V	--	1.5	60	mV
Load Regulation	REGload	1	Tj=25°C	Io=5mA to 1.5A	--	10	120	mV
				Io=250mA to 750mA	--	3	60	mV
Quiescent Current	Iq	3	Tj=25°C	--	2	4	mA	
Quiescent Current Change	Δ Iq	3	Vi=-8 to -25V, Tj=25°C	--	--	1.3	mA	
			Io=5mA to 1.5A, Tj=25°C	--	--	0.5	mA	
Output Noise Voltage	Vn	1	f=10Hz to 100KHz, Ta=25°C	--	44	--	μV	
Ripple Rejection Ratio	RR	2	Vi=-9 to -19V, Io=100mA, f=120Hz	60	73	--	dB	
Min. I/O Voltage Difference	Vdif		Io=1A, Tj=25°C	--	1.1	--	V	
Peak Output Current	Io-peak	1	Tj=25°C	--	2.1	--	A	
Output Voltage Temperature Coefficient	Δ Vo/Ta	1	Io=5mA, Tj=0 to 125°C	--	-0.5	--	mV/°C	

Note: The specified condition Tj=25°C means that the test should be carried out with the test time so short (within 10mS), that the drift in characteristic value due to the rise in chip junction temperature can be ignored.

Rev. 1 03/2003



TS7908 Electrical Characteristics								
(Vin = -14V, Iout = 500mA, Cin = 2μF, Cout = 1μF; Tj = 0°C to 125°C, unless otherwise specified.)								
Characteristic	Symbol	Test Circuit	Condition	Min	Typ	Max	Unit	
Output Voltage	Vo	1	Tj=25°C	-7.69	-8.0	-8.32	V	
Output Voltage Tolerance	Vo	1	Vi=-10.5 to -23V, Io=5mA to 1A, PD<15W	-7.61	-8.0	-8.40	V	
Line Regulation	REGline	1	Tj=25°C	Vi=-10.5 to -25V	--	6	160	mV
				Vi=-11 to -17V	--	2	80	mV
Load Regulation	REGload	1	Tj=25°C	Io=5mA to 1.5A	--	12	160	mV
				Io=250mA to 750mA	--	4	80	mV
Quiescent Current	Iq	3	Tj=25°C	--	2	4	mA	
Quiescent Current Change	Δ Iq	3	Vi=-10.5 to -25V, Tj=25°C Io=5mA to 1.5A	--	--	1	mA	
				--	--	0.5	mA	
Output Noise Voltage	Vn	1	f=10Hz to 100KHz, Ta=25°C	--	52	--	μV	
Ripple Rejection Ratio	RR	2	Vi=-11 to -21V, Io=100mA, f=120Hz	56	71	--	dB	
Min. I/O Voltage Difference	Vdif		Io=1A, Tj=25°C	--	2	--	V	
Peak Output Current	Io-peak	1	Tj=25°C	--	2.1	--	A	
Output Voltage Temperature Coefficient	Δ Vo/Ta	1	Io=5mA, Tj=0 to 125°C	--	-0.6	--	mV/°C	
TS7909 Electrical Characteristics								
(Vin = -15V, Iout = 500mA, Cin = 2μF, Cout = 1μF; Tj = 0°C to 125°C, unless otherwise specified.)								
Characteristic	Symbol	Test Circuit	Condition	Min	Typ	Max	Unit	
Output Voltage	Vo	1	Tj=25°C	-8.65	-9.0	-9.36	V	
Output Voltage Tolerance	Vo	1	Vi=-11.5 to -24V, Io=5mA to 1A, PD<15W	-8.57	-9.0	-9.45	V	
Line Regulation	REGline	1	Tj=25°C	Vi=-11.5 to -26V	--	7	180	mV
				Vi=-12 to -18V	--	2	90	mV
Load Regulation	REGload	1	Tj=25°C	Io=5mA to 1.5A	--	12	180	mV
				Io=250mA to 750mA	--	4	90	mV
Quiescent Current	Iq	3	Tj=25°C	--	2.2	4.5	mA	
Quiescent Current Change	Δ Iq	3	Vi=-11.5 to -26V, Tj=25°C Io=5mA to 1.5A	--	--	1	mA	
				--	--	0.5	mA	
Output Noise Voltage	Vn	1	f=10Hz to 100KHz, Ta=25°C	--	58	--	μV	
Ripple Rejection Ratio	RR	2	Vi=-12 to -22V, Io=100mA, f=120Hz	56	71	--	dB	
Min. I/O Voltage Difference	Vdif		Io=1A, Tj=25°C	--	1.1	--	V	
Peak Output Current	Io-peak	1	Tj=25°C	--	2.1	--	A	
Output Voltage Temperature Coefficient	Δ Vo/Ta	1	Io=5mA, Tj=0 to 125°C	--	-0.6	--	mV/°C	

Note: The specified condition Tj=25°C means that the test should be carried out with the test time so short (within 10mS), that the drift in characteristic value due to the rise in chip junction temperature can be ignored. Rev. 1 03/2003



TS7912 Electrical Characteristics								
(Vin = -19V, Iout = 500mA, Cin = 2μF, Cout = 1μF; Tj = 0°C to 125°C, unless otherwise specified.)								
Characteristic	Symbol	Test Circuit	Condition	Min	Typ	Max	Unit	
Output Voltage	Vo	1	Tj=25°C	-11.53	-12	-12.48	V	
Output Voltage Tolerance	Vo	1	Vi=-14.5 to -27V, Io=5mA to 1A, Pd<15W	-11.42	-12	-12.60	V	
Line Regulation	REGline	1	Tj=25°C	Vi=-14.5 to -30V	--	10	240	mV
				Vi=-16 to -22V	--	3	120	mV
Load Regulation	REGload	1	Tj=25°C	Io=5mA to 1.5A	--	12	240	mV
				Io=250mA to 750mA	--	4	120	mV
Quiescent Current	Iq	3	Tj=25°C	--	2.5	5	mA	
Quiescent current Change	Δ Iq	3	Vi=-14.5 to -30V, Tj=25°C Io=5mA to 1.5A	--	--	1	mA	
				--	--	0.5	mA	
Output Noise Voltage	Vn	1	f=10Hz to 100KHz, Ta=25°C	--	75	--	μV	
Ripple Rejection Ratio	RR	2	Vi=-15 to -25V, Io=100mA, f=120Hz	55	70	--	dB	
Min. I/O Voltage Difference	Vdif		Io=1A, Tj=25°C	--	1.1	--	V	
Peak Output Current	Io-peak	1	Tj=25°C	--	2.1	--	A	
Output Voltage Temperature Coefficient	Δ Vo/Ta	1	Io=5mA, Tj=0 to 125°C	--	-0.8	--	mV/°C	

TS7915 Electrical Characteristics								
(Vin = -23V, Iout = 500mA, Cin = 2μF, Cout = 1μF; Tj = 0°C to 125°C, unless otherwise specified.)								
Characteristic	Symbol	Test Circuit	Condition	Min	Typ	Max	Unit	
Output Voltage	Vo	1	Tj=25°C	-14.42	-15	-15.60	V	
Output Voltage Tolerance	Vo	1	Vi=-17.5 to -30V, Io=5mA to 1A, Pd<15W	-14.28	-15	-15.75	V	
Line Regulation	REGline	1	Tj=25°C	Vi=-17.5 to -30V	--	11	300	mV
				Vi=-20 to -26V	--	3	150	mV
Load Regulation	REGload	1	Tj=25°C	Io=5mA to 1.5A	--	12	300	mV
				Io=250mA to 750mA	--	4	150	mV
Quiescent Current	Iq	3	Tj=25°C	--	2.5	5	mA	
Quiescent current Change	Δ Iq	3	Vi=-17.5 to -30V Io=5mA to 1.5A	--	--	1	mA	
				--	--	0.5	mA	
Output Noise Voltage	Vn	1	f=10Hz to 100KHz, Ta=25°C	--	90	--	μV	
Ripple Rejection Ratio	RR	2	Vi=-18.5 to -28.5V, Io=100mA, f=120Hz	54	69	--	dB	
Min. I/O Voltage Difference	Vdif		Io=1A, Tj=25°C	--	1.1	--	V	
Peak Output Current	Io-peak	1	Tj=25°C	--	2.1	--	A	
Output Voltage Temperature Coefficient	Δ Vo/Ta	1	Io=5mA, Tj=0 to 125°C	--	-0.9	--	mV/°C	

Note: The specified condition Tj=25°C means that the test should be carried out with the test time so short (within 10mS), that the drift in characteristic value due to the rise in chip junction temperature can be ignored.

Rev. 1 03/2003



TS7918 Electrical Characteristics								
(Vin = -27V, Iout = 500mA, Cin = 2μF, Cout = 1μF; Tj = 0°C to 125°C, unless otherwise specified.)								
Characteristic	Symbol	Test Circuit	Condition	Min	Typ	Max	Unit	
Output Voltage	Vo	1	Tj=25°C	-17.30	-18	-18.72	V	
Output Voltage Tolerance	Vo	1	Vi=-21 to -33V, Io=5mA to 1A, PD<15W	-17.14	-18	-18.90	V	
Line Regulation	REGline	1	Tj=25°C	Vi=-21 to -33V	--	15	360	mV
				Vi=-24 to -30V	--	5	180	mV
Load Regulation	REGload	1	Tj=25°C	Io=5mA to 1.5A	--	12	360	mV
				Io=250mA to 750mA	--	4	180	mV
Quiescent Current	Iq	3	Tj=25°C	--	2.5	5	mA	
Quiescent current Change	Δ Iq	3	Tj=25°C	Vi=-21 to -33V, Tj=25°C	--	--	1	mA
				Io=5mA to 1.5A, Tj=25°C	--	--	0.5	mA
Output Noise Voltage	Vn	1	f=10Hz to 100KHz, Ta=25°C	--	110	--	μV	
Ripple Rejection Ratio	RR	2	Vi=-22 to -32V, Io=100mA, f=120Hz	53	68	--	dB	
Min. I/O Voltage Difference	Vdif		Io=1A, Tj=25°C	--	1.1	--	V	
Peak Output Current	Io-peak	1	Tj=25°C	--	2.1	--	A	
Output Voltage Temperature Coefficient	Δ Vo/Ta	1	Io=5mA, Tj=0 to 125°C	--	-1	--	mV/°C	
TS7924 Electrical Characteristics								
(Vin = -33V, Iout = 500mA, Cin = 2μF, Cout = 1μF; Tj = 0°C to 125°C, unless otherwise specified.)								
Characteristic	Symbol	Test Circuit	Condition	Min	Typ	Max	Unit	
Output Voltage	Vo	1	Tj=25°C	-23.07	-24	-24.96	V	
Output Voltage Tolerance	Vo	1	Vi=-27 to -38V, Io=5mA to 1A, PD<15W	-22.85	-24	-25.20	V	
Line Regulation	REGline	1	Tj=25°C	Vi=-27 to -38V	--	18	480	mV
				Vi=-30 to -36V	--	6	240	mV
Load Regulation	REGload	1	Tj=25°C	Io=5mA to 1.5A	--	12	480	mV
				Io=250mA to 750mA	--	4	240	mV
Quiescent Current	Iq	3	Tj=25°C	--	3	5	mA	
Quiescent current Change	Δ Iq	3	Tj=25°C	Vi=-27 to -38V, Tj=25°C	--	--	1	mA
				Io=5mA to 1.5A, Tj=25°C	--	--	0.5	mA
Output Noise Voltage	Vn	1	f=10Hz to 100KHz, Ta=25°C	--	170	--	μV	
Ripple Rejection Ratio	RR	2	Vi=-28 to -38V, Io=100mA, f=120Hz	50	65	--	dB	
Min. I/O Voltage Difference	Vdif		Io=1A, Tj=25°C	--	1.1	--	V	
Peak Output Current	Io-peak	1	Tj=25°C	--	2.1	--	A	
Output Voltage Temperature Coefficient	Δ Vo/Ta	1	Io=5mA, Tj=0 to 125°C	--	-1	--	mV/°C	

Note: The specified condition Tj=25°C means that the test should be carried out with the test time so short (within 10mS), that the drift in characteristic value due to the rise in chip junction temperature can be ignored. Rev. 1 03/2003

Test Circuit 1

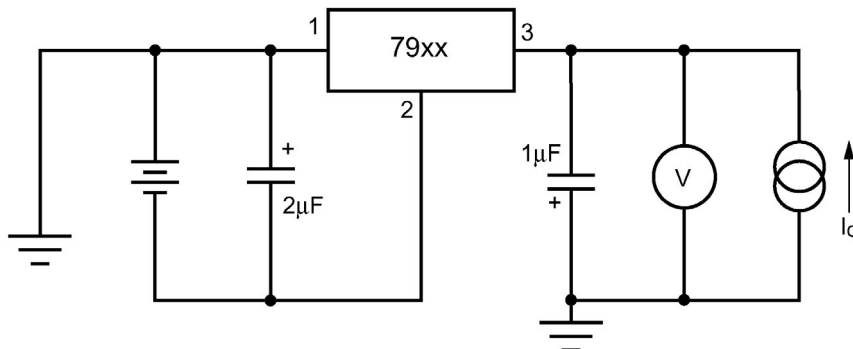

Test Circuit 2

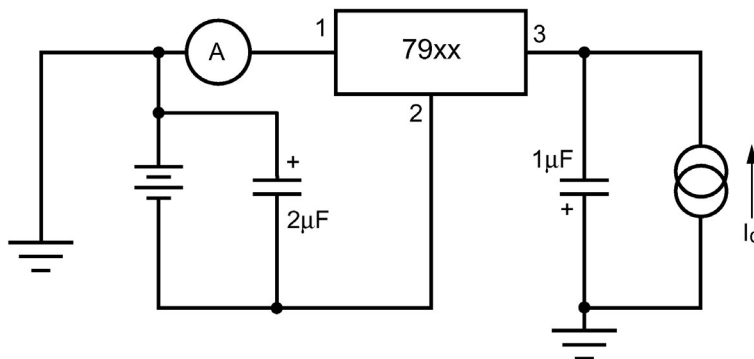

Test Circuit 3

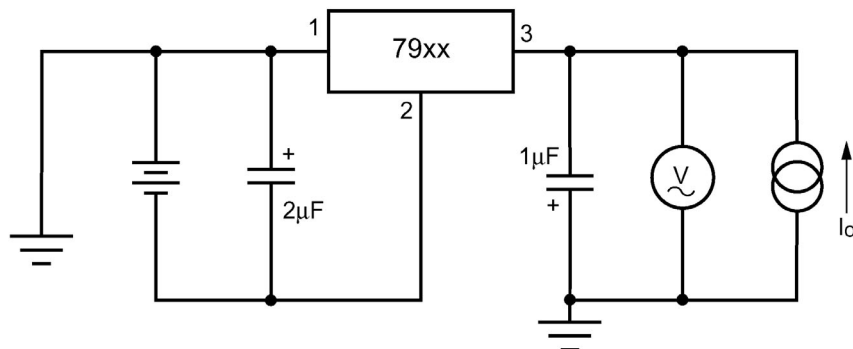



Ratings and Characteristic Curves ($T_A = 25^\circ\text{C}$ unless otherwise noted)

FIG. 1 - Power Dissipation vs. Ambient Temperature

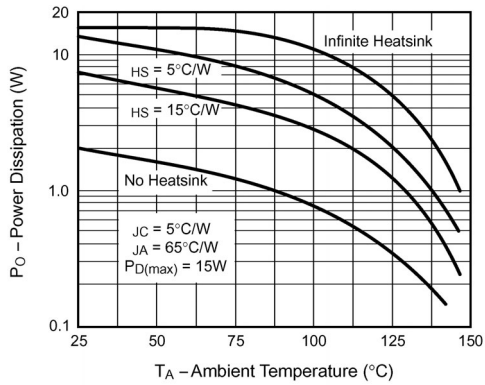

FIG. 2 - Quiescent Current

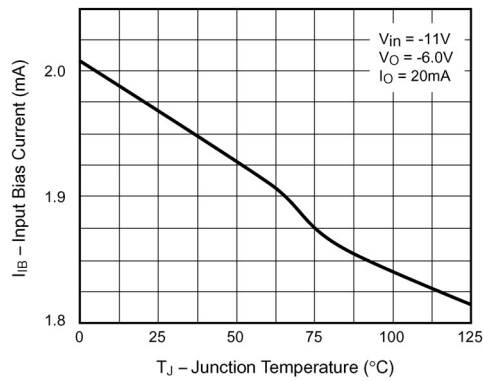

FIG. 3 - Peak Output Current

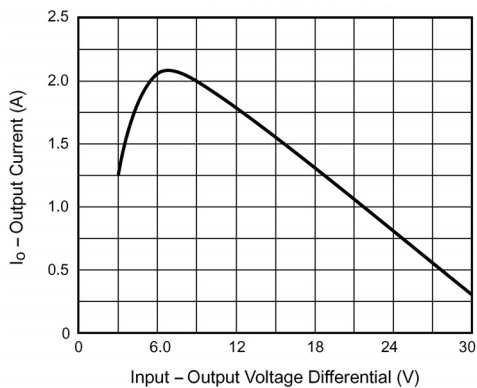

FIG. 4 - Ripple Rejection Ratio vs. Frequency

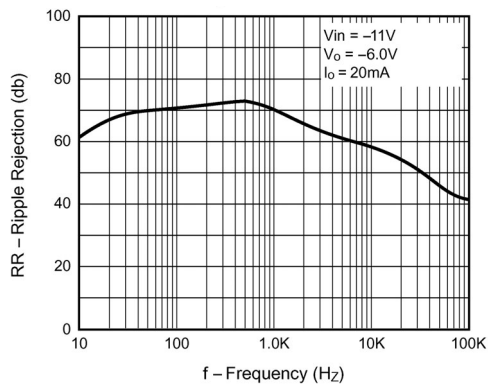

FIG. 5 - Ripple Rejection vs. Output Voltage

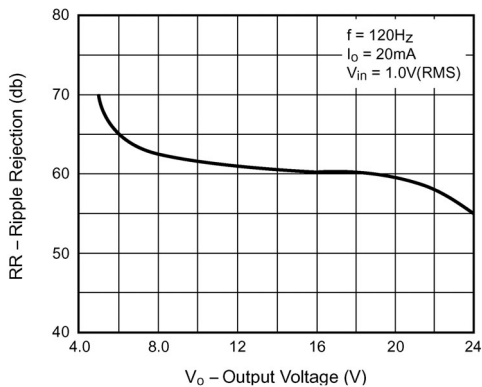
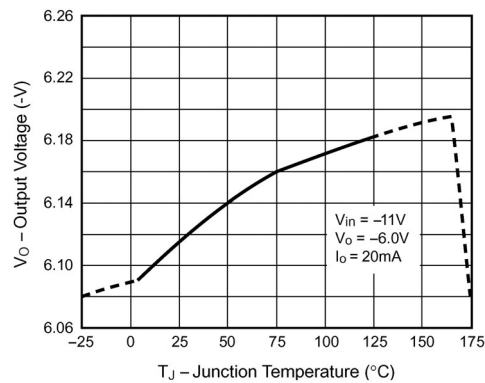

FIG. 6 - Output Voltage vs. Junction Temperature



Rev. 1 03/2003



TO-220 Mechanical drawing		TO-220 DIMENSION			
DIM	MILLIMETERS		INCHES		
	MIN	MAX	MIN	MAX	
A	10.00	10.50	0.394	0.413	
B	3.24	4.44	0.128	0.175	
C	2.44	2.94	0.096	0.116	
D	3.565	4.315	0.140	0.170	
E	0.68	0.92	0.027	0.036	
F	1.115	1.485	0.044	0.058	
G	2.345	2.715	0.092	0.107	
H	13.49	14.31	0.531	0.563	
I	4.475	5.225	0.176	0.206	
J	1.15	1.39	0.045	0.055	
K	27.78	29.62	1.094	1.166	
L	2.175	2.925	0.086	0.115	
M	0.297	0.477	0.012	0.019	
N	8.28	8.80	0.326	0.346	
O	14.29	15.31	0.563	0.603	
P	6.01	6.51	0.237	0.256	

TO-220F Mechanical drawing		TO-220F DIMENSION			
DIM	MILLIMETERS		INCHES		
	MIN	MAX	MIN	MAX	
A	9.9	10.1	0.390	0.398	
B	6.2	6.2	0.244	0.244	
C	2.2	2.2	0.087	0.087	
D	1.4	1.4	0.055	0.055	
E	15.0	15.2	0.591	0.598	
F	0.48	0.72	0.019	0.028	
G	2.355	2.725	0.093	0.107	
H	13.49	14.31	0.531	0.563	
I	1.115	1.485	0.044	0.058	
J	2.6	2.8	0.102	0.110	
K	4.4	4.6	0.173	0.181	
L	1.115	1.15	0.045	0.045	
M	2.95	3.15	0.116	0.124	
N	2.6	2.8	0.102	0.110	
O	6.55	6.65	0.258	0.262	

Rev. 1 03/2003